



QSG TAP200

[Main Page](#) > [TAP Access Points](#) > [TAP200](#) > **QSG TAP200**

This Wiki page contains the online version of the **Quick Start Guide (QSG)** for the **TAP200 Access Point**. Here you will find an overview of the various components for TAP200 device, hardware installation instructions, first login information, device specifications, and general safety information. It is highly recommended to acquaint yourself with the Quick Start Guide before using the device.



Safety information

Before starting operating the device, please review recommendations and precautions to minimize the possibility of accidents. Safety precautions presented are supplementary and subject to the local safety regulations. When various operations are executed on the device, the user must fully follow the safety instructions and recommendations provided with the device.

General

Radio specifications	
RF technologies	Wi-Fi
Max RF power	20 dBm@WiFi 2.4G, 23 dBm@WiFi 5G
Integrated antennas specifications	
Wi-Fi antennas	2x 2400-2500 MHz, peak gain < 4.9 dBi, omnidirectional, 2x 5150-5850 MHz, peak gain < 5.02 dBi, omnidirectional
Bundled accessories specifications*	
Power adapter	Input: 0.5 A@100-240V VAC, Output: 52 VDC, 0.35A, 802.3af

* Order code dependant.

TAP200 access point must be used in compliance with any and all applicable national and international laws and with any special restrictions regulating the utilization of the communication module in prescribed applications and environments.

CE Declaration of Conformity

[BG] Bulgarian	С настоящото TELTONIKA NETWORKS декларира, че този TAP200 е в съответствие със съществените изисквания и други разпоредби на Директиви 2014/53/EU, 2011/65/EU, 2009/125/EC.
[HR] Croatian	Ovim TELTONIKA NETWORKS izjavljuje da je ovaj TAP200 u skladu s bitnim zahtjevima i ostalim relevantnim odredbama Direktive 2014/53/EU, 2011/65/EU, 2009/125/EC.
[CZ] Czech	Společnost TELTONIKA NETWORKS tímto prohlašuje, že tento TAP200 splňuje základní požadavky a další ustanovení směrnic 2014/53/EU, 2011/65/EU, 2009/125/EC.
[DK] Danish	Undertegnede TELTONIKA NETWORKS erklærer herved, at følgende udstyr TAP200 overholder de væsentlige krav og øvrige relevante krav i direktiv 2014/53/EU, 2011/65/EU, 2009/125/EC.
[NL] Dutch	Hereby, TELTONIKA NETWORKS declares that this TAP200 is in compliance with the essential requirements and other relevant provisions of Richtlijn 2014/53/EU, 2011/65/EU, 2009/125/EC.
[EE] Estonian	Käesolevaga kinnitab TELTONIKA NETWORKS seadme TAP200 vastavust Direktiivide 2014/53/EU, 2011/65/EU, 2009/125/EC põhinõuetele ja nimetatud direktiivist tulenevatele teistele asjakohastele sätetele.
[FI] Finnish	TELTONIKA NETWORKS vakuuttaa täten että TAP200 tyyppinen laite on Direktiivien 2014/53/EU, 2011/65/EU, 2009/125/EC oleellisten vaatimusten ja sitä koskevien direktiivin muiden ehtojen mukainen.
[FR] French	TELTONIKA NETWORKS déclare par la présente que ce TAP200 est conforme aux exigences essentielles et autres dispositions des Directives 2014/53/EU, 2011/65/EU, 2009/125/EC.
[DE] German	TELTONIKA NETWORKS erklärt hiermit, dass dieses TAP200 den grundlegenden Anforderungen und anderen Bestimmungen der Richtlinien 2014/53/EU, 2011/65/EU, 2009/125/EC entspricht.
[GR] Greek	Η TELTONIKA NETWORKS δηλώνει ότι το παρόν TAP200 συμμορφώνεται με τις βασικές απαιτήσεις και άλλες διατάξεις των Οδηγιών 2014/53/EU, 2011/65/EU, 2009/125/EC.
[HU] Hungarian	A TELTONIKA NETWORKS kijelenti, hogy ez a TAP200 megfelel a 2014/53/EU, 2011/65/EU, 2009/125/EC irányelvek alapvető követelményeinek és egyéb rendelkezéseinek.
[IE] Irish	Leis seo, dearbhaíonn TELTONIKA NETWORKS go gcomhlíonann an TAP200 seo bunriachtanais agus forálacha ábhartha eile Threoir 2014/53/EU, 2011/65/EU, 2009/125/EC.
[IT] Italian	Con la presente, TELTONIKA NETWORKS dichiara che questo TAP200 è conforme ai requisiti essenziali e ad altre disposizioni pertinenti della Direttive 2014/53/EU, 2011/65/EU, 2009/125/EC.
[LV] Latvian	TELTONIKA NETWORKS ar šo paziņo, ka šis TAP200 atbilst pamatprasībām un citiem Direktīvas 2014/53/EU, 2011/65/EU, 2009/125/EC noteikumiem.
[LT] Lithuanian	Šiuo dokumentu UAB TELTONIKA NETWORKS deklaruoja, kad šis TAP200 atitinka esminius reikalavimus ir kitas 2014/53/EU, 2011/65/EU, 2009/125/EC Direktyvų nuostatas.
[MT] Maltese	TELTONIKA NETWORKS b'dan tiddikjara li dan TAP200 jikkonforma mar-rekwiżiti essenzjali u dispożizzjonijiet oħra tad-Direttivi 2014/53/EU, 2011/65/EU, 2009/125/EC.
[NO] Norwegian	TELTONIKA NETWORKS erklærer herved at denne TAP200 er i samsvar med de grunnleggende kravene og andre bestemmelser i Direktivene 2014/53/EU, 2011/65/EU, 2009/125/EC.
[PL] Polish	TELTONIKA NETWORKS niniejszym oświadcza, że niniejszy TAP200 jest zgodny z zasadniczymi wymaganiami i innymi postanowieniami Dyrektyw 2014/53/EU, 2011/65/EU, 2009/125/EC.
[PT] Portuguese	A TELTONIKA NETWORKS declara que esta TAP200 cumpre os requisitos essenciais e outras disposições das Directivas 2014/53/EU, 2011/65/EU, 2009/125/EC.
[RO] Romanian	TELTONIKA NETWORKS declară prin prezenta că acest TAP200 este în conformitate cu cerințele esențiale și cu alte dispoziții ale Directivelor 2014/53/EU, 2011/65/EU, 2009/125/EC.
[SK] Slovak	Spoločnosť TELTONIKA NETWORKS týmto vyhlasuje, že tento TAP200 spĺňa základné požiadavky a ďalšie ustanovenia smerníc 2014/53/EU, 2011/65/EU, 2009/125/EC.
[SI] Slovenian	TELTONIKA NETWORKS izjavlja, da je ta TAP200 skladen z bistvenimi zahtevami in drugimi določbami Direktiv 2014/53/EU, 2011/65/EU, 2009/125/EC.
[ES] Spanish	TELTONIKA NETWORKS declara por la presente que este TAP200 cumple los requisitos esenciales y otras disposiciones de las Directivas 2014/53/EU, 2011/65/EU, 2009/125/EC.
[SE] Swedish	TELTONIKA NETWORKS förklarar härmed att denna TAP200 uppfyller de grundläggande kraven och andra bestämmelser i Direktiven 2014/53/EU och 2011/65/EU, 2009/125/EC.

Detailed compliance information is available at the following internet address: wiki.teltonika-networks.com/view/Certificates (<https://wiki.teltonika-networks.com/view/Certificates>).



This sign means that it is necessary to read the User's Manual before you start using the device.



This sign on the package means that all used electronic and electric equipment should not be mixed with general household waste.



Hereby, TELTONIKA NETWORKS declares that this TAP200 is in compliance with the essential requirements and other relevant provisions of Directives 2014/53/EU, 2011/65/EU, 2009/125/EC. The full text of the EU Declaration of Conformity is available at the following internet address: wiki.teltonika-networks.com/view/TAP200_CE/RED (https://wiki.teltonika-networks.com/view/TAP200+_CE/RED)



Hereby, TELTONIKA NETWORKS declares that this TAP200 is in compliance with Radio Equipment Regulations 2017, The Restriction of the Use of Certain Hazardous Substances in Electrical and Electronic Equipment Regulations 2012, The Ecodesign for Energy-Related Products and Energy Information (Amendment) (EU Exit) Regulations 2019. The full text of the UK Declaration of Conformity is available at the following internet address: wiki.teltonika-networks.com/view/TAP200_UKCA (<https://wiki.teltonika-networks.com/view/TAP200+UKCA>)

RF exposure

This device meets the official requirements for exposure to radio waves. This device is designed and manufactured not to exceed the emission limits for exposure to radio frequency (RF) energy set by authorized agencies. The device must be used with a minimum separation of 20 cm from a person's body to ensure compliance with RF exposure guidelines. Failure to observe these instructions could result in your RF exposure exceeding the applicable limits.

External antennas used with TAP200 must be installed to provide a distance of at least 20 cm from any people and must not be co-located or operated in conjunction with any other antenna or transmitter.

Any external antenna gain must meet RF exposure and maximum radiated output power limits of the applicable rule section.

Operating Frequency / Maximum transmission power	
Wi-Fi 2.4 GHz	2412-2472 MHz, 20 dBm

Operating conditions

- Operating temperature: -40° to +50° Celsius

- Humidity should be in the range of 10% to 90% (non-condensing). Only use the device in dry environments.
- Out of direct sunlight
- Away from heat source, corrosive substances, salts, and flammable gases

Attention: operation outside the permissible range can considerably shorten the service life of the device.

Faulty and damaged products

- Do not attempt to disassemble the device or its accessories.
- Only qualified personnel must service or repair the device or its accessories.
- If your device or its accessories have been submerged in water punctured or subjected to a severe fall, do not use until they have been checked at an authorized service center.

Electrical safety

- Only use approved accessories.
- Do not connect with incompatible products or accessories.
- It is recommended to ground devices with grounding terminals before connecting them to power. Failure to ground appropriately might result in a shock hazard. The cross-sectional area of the protective grounding conductor should be at least 1mm².

Product handling

- You alone are responsible for how you use your device and any consequences related to its use.
- Use of your device is subject to safety measures designed to protect users and their environment.
- Always treat your device and its accessories with care and keep it in a clean and dust-free place.
- Do not expose your device or its accessories to open flames, lit tobacco products, liquid, moisture, or high humidity.
- Do not drop, throw or try to bend your device or its accessories.
- Do not use harsh chemicals, cleaning solvents, or aerosols to clean the device or its accessories.
- Do not paint your device or its accessories.
- Do not attempt to disassemble your device (exemptions for devices that require disassembly for SIM insertion) or its accessories: it does not contain any user-serviceable parts. For safety reasons, the equipment should be opened only by qualified personnel.
- Make sure to use ESD personal protective equipment while the equipment is serviced.
- Do not use your device in an enclosed environment where heat dissipation is poor.
- Prolonged use in such space may cause excessive heat and raise ambient temperature, which will lead to the automatic shutdown of your device or the disconnection of the mobile network connection for your safety. To use your device again after such a shutdown, cool it in a well-ventilated place before turning it on.
- Please check all national laws and local regulations for the disposal of electronic products.
- Do not operate the device where ventilation is restricted.
- Do not use or install this product near water to avoid fire or shock hazards.

- Avoid exposing the equipment to rain or damp areas.
- Arrange power and Ethernet cables so that they are not likely to be stepped on or have items placed on them.
- Ensure that the voltage and the rated current of the power source match the device's requirements. Do not connect the device to an inappropriate power source.
- During a thunderstorm, no operations should be carried out on the device and cables.
- The unit must be powered off where blasting is in progress and explosive atmospheres are present or near medical life support equipment.
- Do not leave your device and its accessories within reach of small children or allow them to play with it. They could hurt themselves or others and could accidentally damage the device. Your device contains small parts with sharp edges that may cause an injury choking hazard.
- Like any wireless device, this device operates using radio signals, which cannot guarantee connection in all conditions. Therefore, you must never rely solely on any wireless device for emergency communications or otherwise use the device in situations where the interruption of data connectivity could lead to death, personal injury, property damage, data, or other loss.
- The device may become warm during regular use.

Bottom view

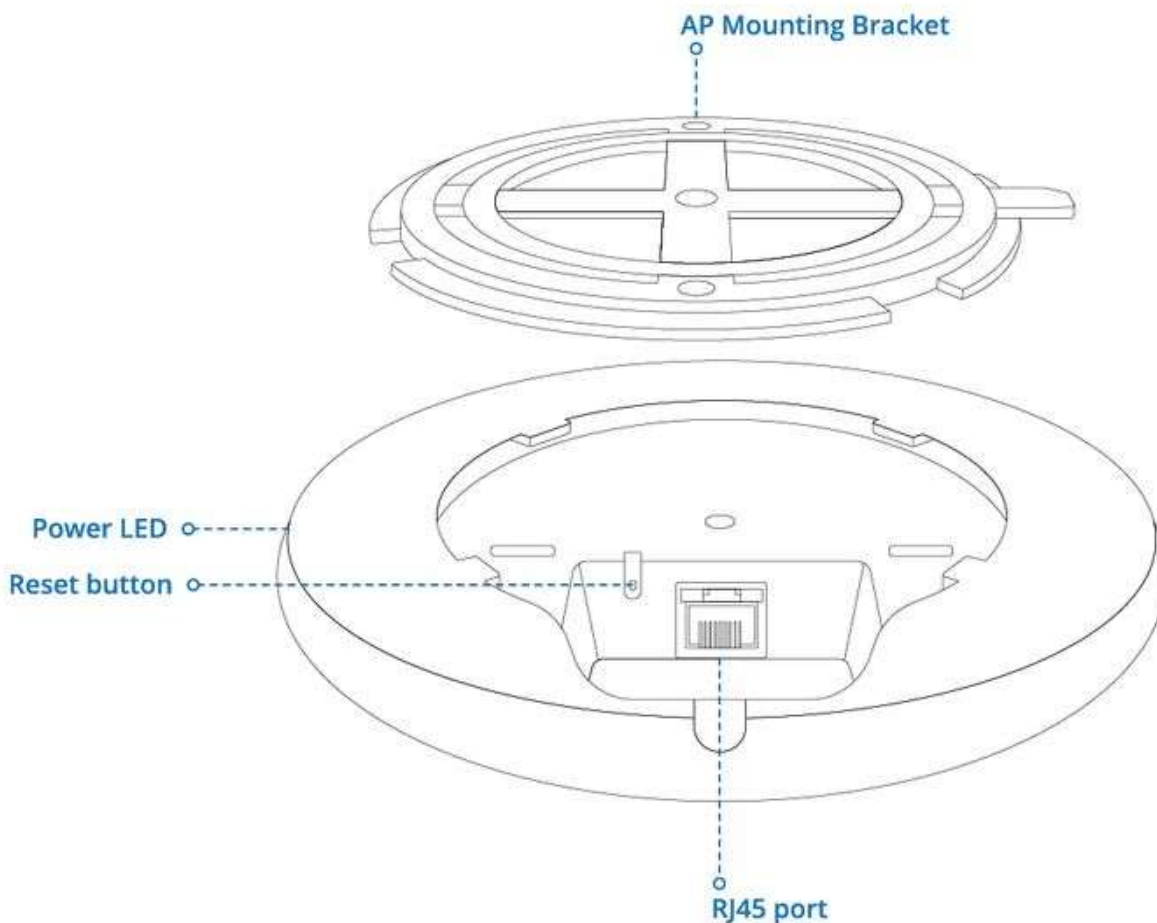

AP Mounting Bracket Lock

0:00 / 0:02

TAP200 RJ45 Port



Video Quick Start Guide

Need some help setting up your new Teltonika Networks TAP10 Access Point? Watch our quick start guide video and follow the step-by-step instructions to set up your new access point for operation easily.

TAP200 Wi-Fi 5 Access Point | Quick Start Guide



Installation Guide

1. Remove the AP Mounting Bracket from the TAP200 access point.

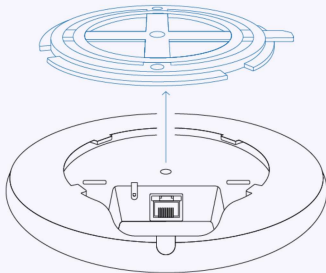

2. Connect one end of the Ethernet cable to the RJ45 port located at the bottom of the TAP200 Access Point, and the other end to the PWR PoE port of the PoE injector. Then, plug the PoE injector into an electrical outlet.

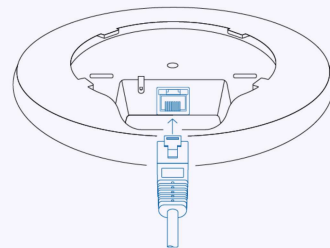

3. Connect the Ethernet cable from your internet source, such as a switch, gateway, or router, to the Ethernet IN port on the PoE injector.

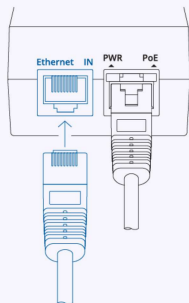

4. Connect to the TAP200 wirelessly using the SSID and password found on the TAP200 information label.

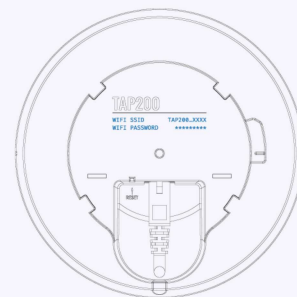

Mounting instruction

1. Mount the AP Mounting Bracket using screws (not included). Mounting holes are \varnothing 4.6 cm. You can find more

2. Ensure the AP Mounting Bracket is secure and the

in [TAP200 Spatial Measurements page \(https://wiki.teltonika-networks.com/view/TAP200_Spatial_Measurements_%26_Weight\)](https://wiki.teltonika-networks.com/view/TAP200_Spatial_Measurements_%26_Weight).

Ethernet cable is ready.



3. Connect the LAN cable and orient the TAP200 RJ45 port at a 90-degree angle to the AP Mounting Bracket lock.

4. Turn the TAP200 counterclockwise to lock it onto the AP Mounting Bracket.

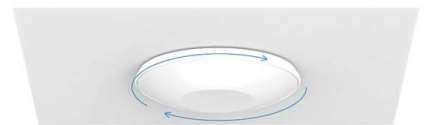

TAP200 Login to device

If you need to configure the TAP200 without an internet connection, please refer to the guide in this section.

1. Ensure the Wireless network connection is Enabled. Go to Start — Control Panel — Network and Internet — Network and Sharing Center. Click on the **Change adapter settings** in

the left panel, then right-click on Wireless Network Adapter, and select Enable.

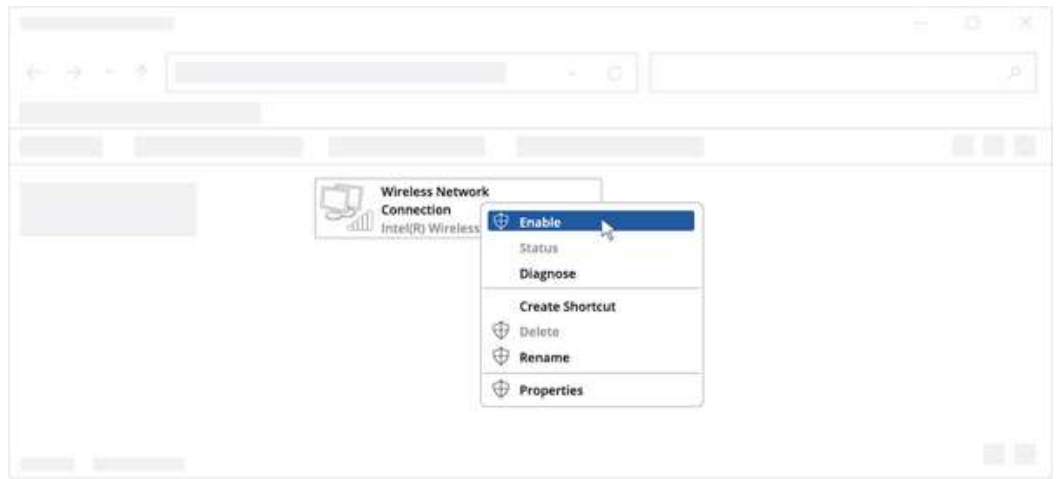

2. Right-click on Wireless Network Connection and select Properties. Then select **Internet Protocol Version 4** and click Properties.

3. If not selected, check to **Use the following IP address** and enter **192.168.1.5**.

4. Click in the **Subnet mask** it should get auto-filled with 255.255.255.0. Click OK.

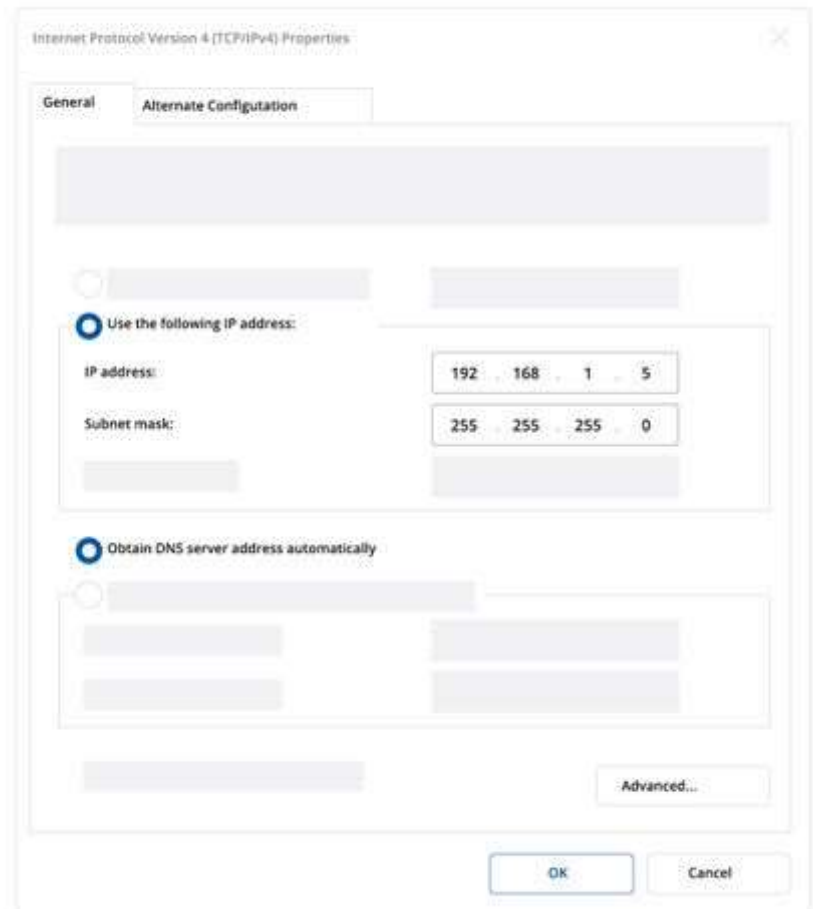

5. Connect to a wireless network by right-clicking on Wireless Network Adapter and selecting Connect.

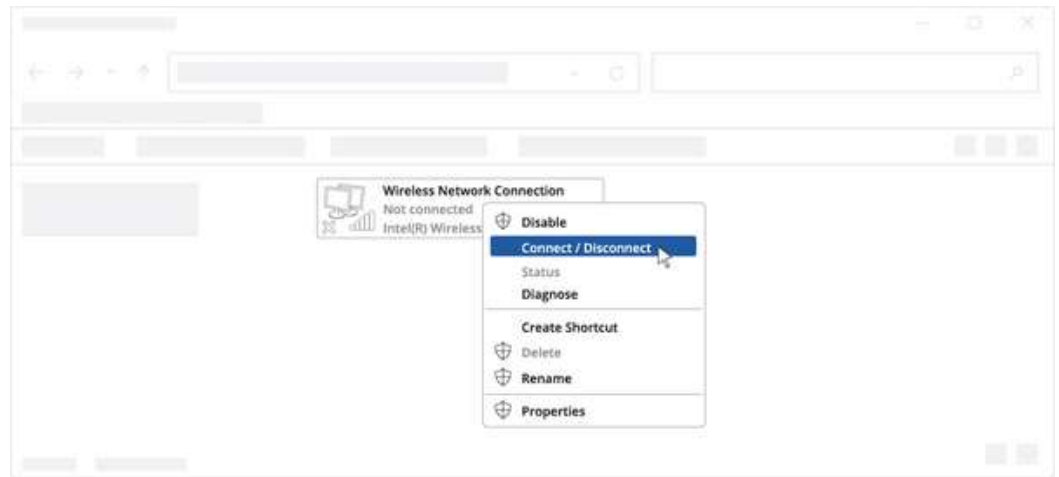

6. Choose the wireless network TAP200 **** from the list and click Connect. Enter the WiFi password located on the device's label.

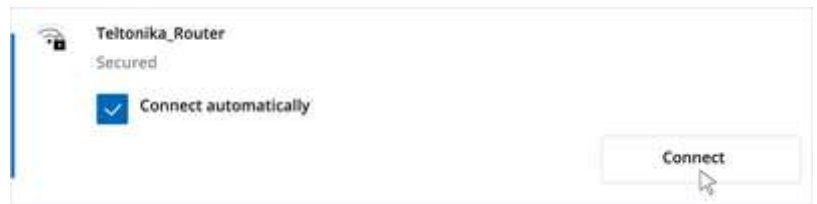

7. To enter the router's Web interface (WebUI), type <http://192.168.1.3> into the URL field of your Internet browser.

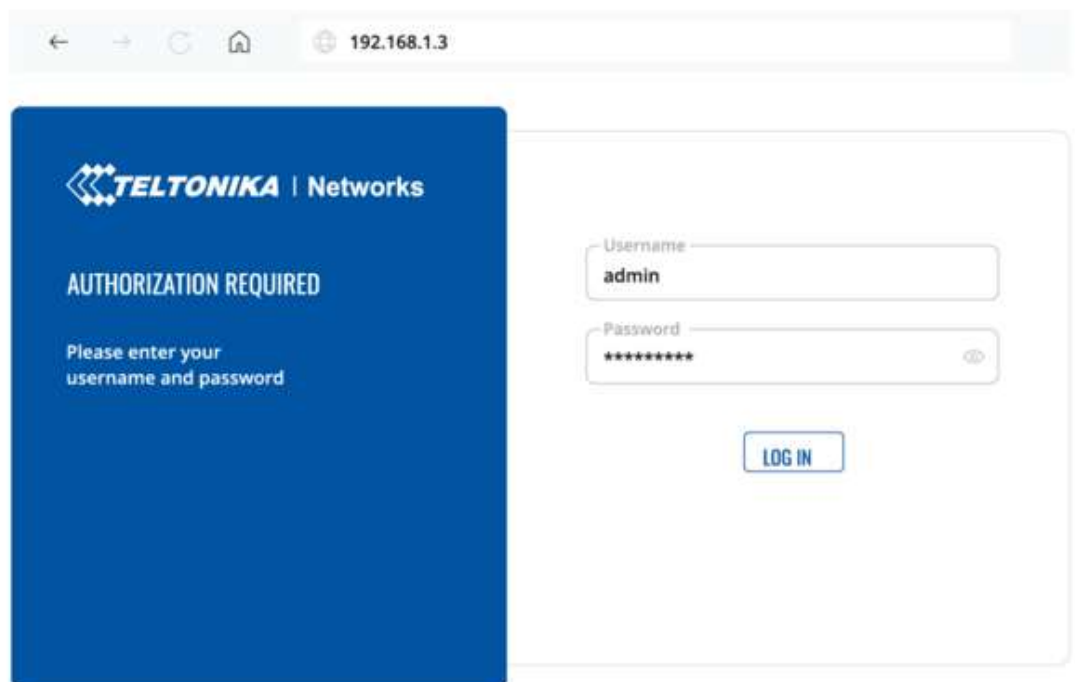

8. When prompted for authentication enter the username admin and enter the password located on the device information label/engraving.

Retrieved from "https://wiki.teltonika-networks.com/index.php?title=QSG_TAP200&oldid=132164"

■