

SMART-WAY RACEWAY SYSTEM

FSR

Power Products Group

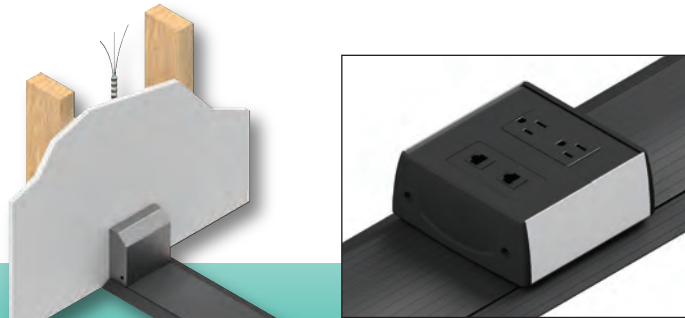

Patent Pending.



DESCRIPTION

The Smart-Way Raceway System is the intelligent choice for wire management. **It is now configurable for either on top of (vinyl, carpet, wood) or in any flooring (carpet, wood, tile, laminate) with the provided edging.**

The Smart-Way Raceway gets cables where they're needed. The Raceway is intended for offices, conference rooms, collaborative work environments, classrooms or anywhere wire management is desired. The Raceway compartments provide ample space for power, communications and A/V connectivity with the capacity to hold (14) 12 AWG (.130" diameter) power conductors, and (9) CAT 5E (.215" diameter), or (5) CAT 6A (.250" diameter) data cables.

The Smart-Way is only 0.6" high, ADA compliant, available in slate gray or aluminum finishes and is sold in sections. Its design includes centering V-grooves in the track to locate pilot/clearance holes for securing fasteners. Optional Elbow Kits are available to make 45 or 90-degree angles that will not compromise the minimum bend radius of the cables.

It's the most cost-effective and easiest way to get your power, data and AV across the room to where you really need it.

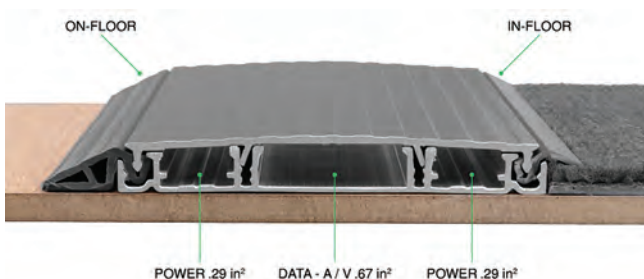

FEATURES

- Installs on top of or in any flooring for a quick installation
- Ultra-low profile
- ADA compliant
- Competitive pricing
- Raceway compartments provide ample space for power, Communications, and A/V requirements
- Sold in 1', 3', 6' sections or in a 1'2'3' saw-less installation kit
- Available in slate gray or aluminum finishes
- Optional elbow kits for making 45 or 90-degree angle turns which will not compromise the minimal bend radius of wire

Smart-Way Floor Mounted Raceway Load Capacity Chart

Component Type	Tire Load lbs.*	Axle Load lbs.*	Concentrated Load lbs.*
Raceway Straight Sections	8,000	16,000	1,500
Corner Fittings	2,500	5,000	1,000
Tee Fittings	1,500	3,000	1,000

*- Tire load test mandrel, rubber faced 16.5" x 4";

** - Concentrated load test mandrel, 3" round rubber faced.

Note:

1. Raceway mounted directly to a hard surface simulating an In-Carpet or On-Concrete installation.

2. The raceway is designed for light vehicle roll over and pedestrian traffic.

FSR Inc.

244 Bergen Boulevard, Woodland Park, NJ 07424

Phone: 973.785.4347 · Fax: 973.785.4207

Web: www.fsrinc.com · E-mail: sales@fsrinc.com

LIT1749I

Smart-Way Raceway Lengths

One end stop (SW-END) is required at the end of the Raceway.

18203	SW-T72-ALM	72" Raceway Aluminum
18204	SW-T72-SLT	72" Raceway Slate Gray
18297	SW-T36-ALM	36" Raceway Aluminum
18298	SW-T36-SLT	36" Raceway Slate Gray
18299	SW-T12-ALM	12" Raceway Aluminum
18300	SW-T12-SLT	12" Raceway Slate Gray
18301	SW-T123-ALM	1', 2', 3' Saw-less Installation Kit
18302	SW-T123-SLT	1', 2', 3' Saw-less Installation Kit

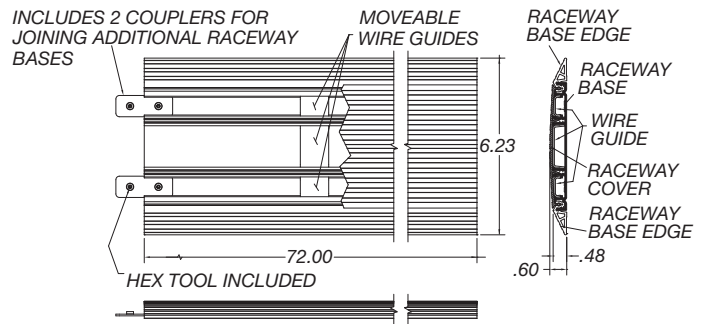

Each section includes a base and cover, couplers, moveable wire guides, raceway base edges, and a hex tool for installation.

Smart-Way Corners and Fittings

18207	SW-L90-ALM	90° Corner Aluminum
18208	SW-L90-SLT	90° Corner Slate Gray
18303	SW-L45-ALM	45° Corner Aluminum
18304	SW-L45-SLT	45° Corner Slate Gray

The Smart-Way corners come in either a 45° or 90° corner. Both corners are available in aluminum and slate gray. The corner kits transition the cables seamlessly around a corner without compromising the minimal bend radius.

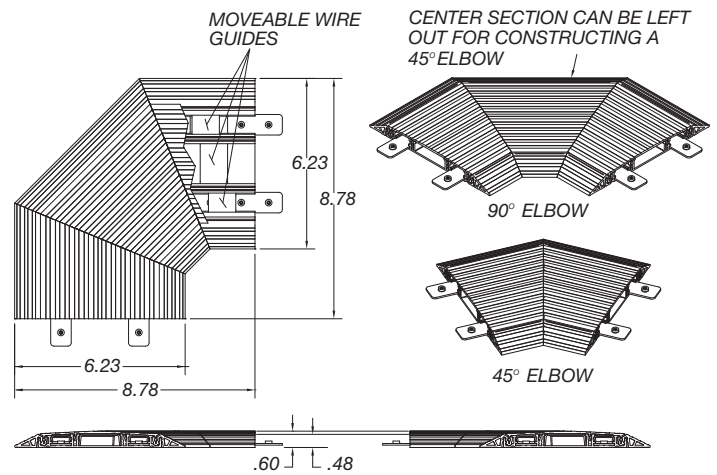

Moveable wire guides are provided with the raceway.

Smart-Way Fitting Tee

18305	SW-TEE-ALM	Two Part Tee
18306	SW-TEE-SLT	Two Part Tee

The two part tee allows cables to go in both directions to reach the required destination without any complications.

Both outer power channels are used to deliver AC to each leg independently.

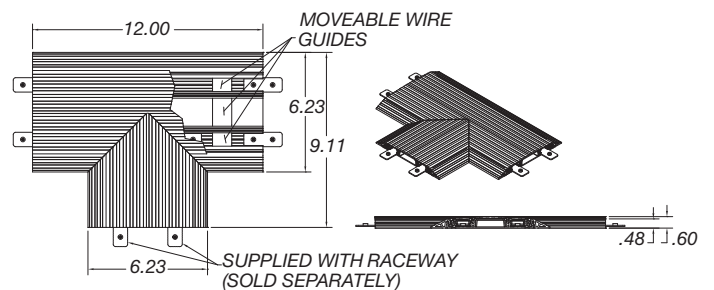

90° OPPOSING TURNS

STRAIGHT + 90° TURN

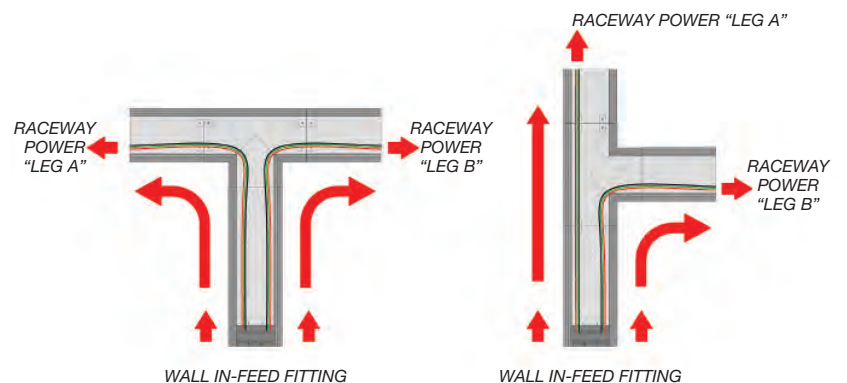

Visit www.fsrinc.com for detailed drawings and installation documents.

Smart-Way Device Boxes



18211 SW-DB-1P1D

2 gang device box with 1 power and 1 low voltage Decora opening, the divider is not removable.

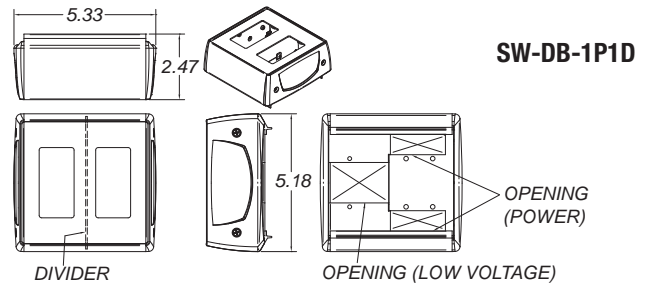

18212 SW-DB-2P

2 gang device box with 2 power Decora openings (NEMA spacing). Accesses the 2 outer channels only.

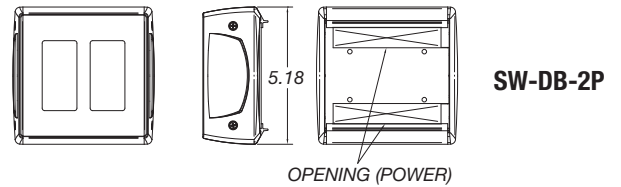

18213 SW-DB-2D

2 gang device box with 2 low voltage Decora openings (NEMA spacing). Accesses the inner channel only.

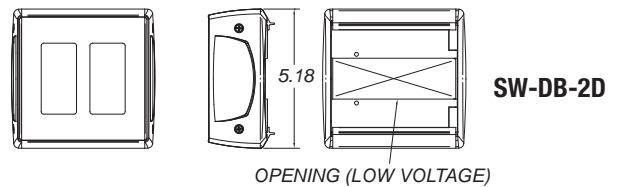

18214 SW-DB-2P1D

3 gang device box with 2 power and 1 low voltage Decora opening. The two power openings have NEMA spacing. The compartments access the appropriate track channels, can't be interchanged, and the divider is not removable.

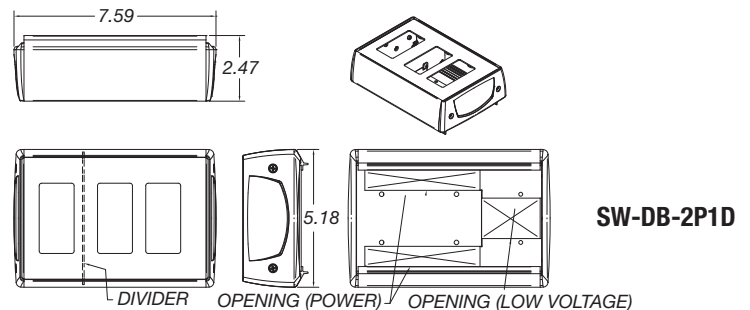

18215 SW-DB-1P2D

3 gang device box with 1 power and 2 low voltage Decora openings. The two low voltage openings have NEMA spacing. The compartments access the appropriate track channels, can't be interchanged, and the divider is not removable.

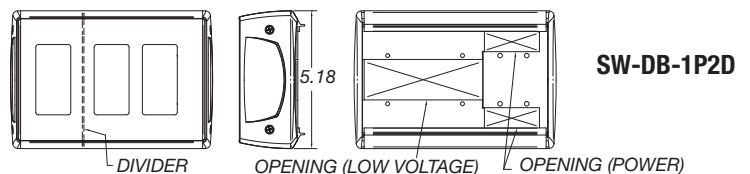

International Device Boxes, Plate Inserts and Power Receptacles

18337 SW-IDB-2P

International Device Box with 2 openings for power inserts.

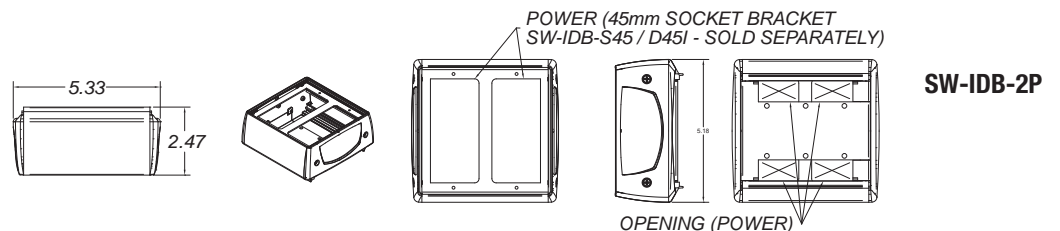

18338 SW-IDB-1P1D

International Device Box with openings for 1 power insert/1 Decora opening.

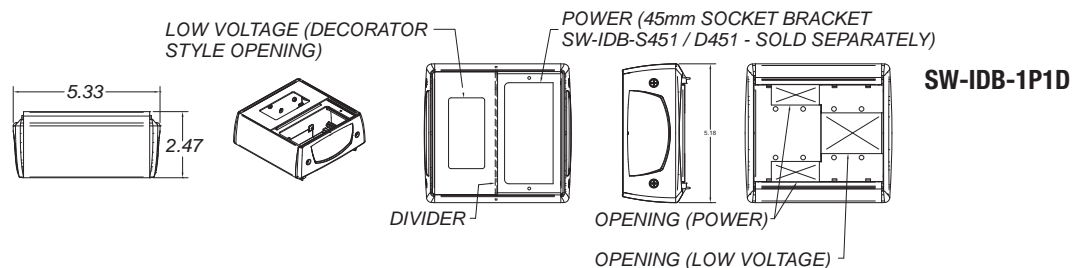

18339 SW-IDB-1P2D

SW-IDB-1P2D

International Device Box with 1 openings for power Insert/2 Decora openings.

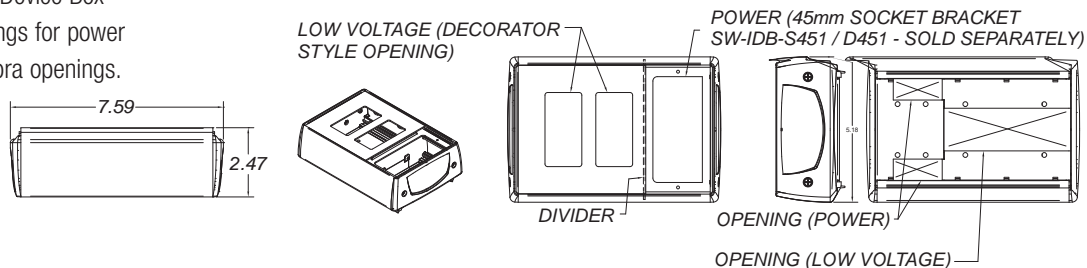

18340 SW-IDB-D45I

SW-IDB-D45I

Device Plate Insert w/ 2-45mm openings for power receptacles.

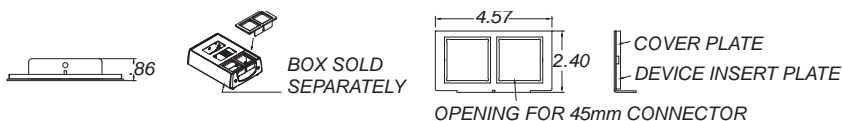

18341 SW-IDB-S45I

SW-IDB-S45I

Device Plate Insert w/ 45mm opening for a power receptacle.

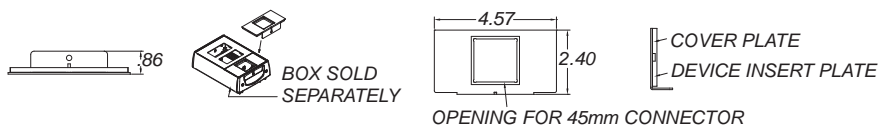

18356 SOC45-UN

45mm Universal Socket 10 Amp / 250VAC

18357 SOC45-TF

45mm Type F SCHUKO - Europe & Russia 16 Amp / 250VAC

18358 SOC45-TI

45mm Type I - Australia, New Zealand, China & Argentina 10 Amp / 240VAC

18359 SOC45-TG

45mm Type G - UK, Ireland, Malta, Malaysia & Singapore 13 Amp / 250VAC

Smart-Way Hardwired Raceway Transitions

18216 SW-DB-1HWP1D

SW-DB-1HWP1D

2 gang device box with 1 gang power - 1 1/2" & 3/4" KO - and 1 gang low voltage Decora opening.

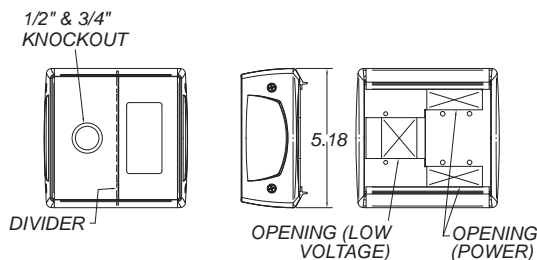

18320 SW-FCT-SLT

SW-FCT-SLT

Flexible conduit transition with removable dividers. Its small design allows wires and cables to transition from the Smart-Way raceway to tables via conduit. 3/4" Rubber bushing provided.

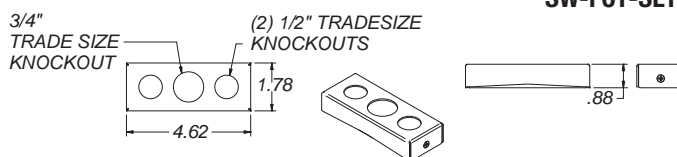

Smart-Way Wall Feed Boxes

For New or Old Construction

18217 SW-WF-LP-ALM

18219 SW-WF-LP-SLT

Wall feed for 1 or 2 circuits of power and low voltage feed through.

SW-WF-LP



18218 SW-WF-HP-ALM

18220 SW-WF-HP-SLT

Wall feed for 2 or more circuits of power and low voltage feed through.

SW-WF-HP



18332 SW-WF-WLP-SLT

Wall Feed for metal stud only with 1 or 2 circuits of power per channel and low voltage.

SW-WF-WLP-SLT

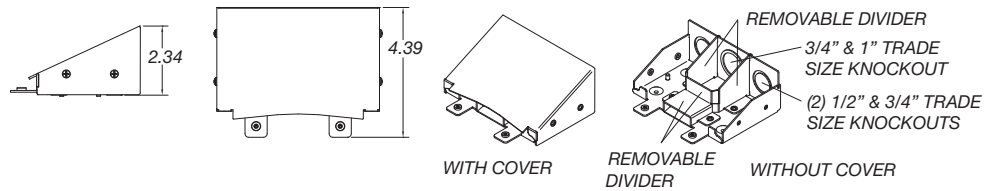

For New Construction

18317 SW-WF-RIN

In-wall rough-in feed with construction cover. Use with SW-RINLP on-wall feed.

SW-WF-RIN

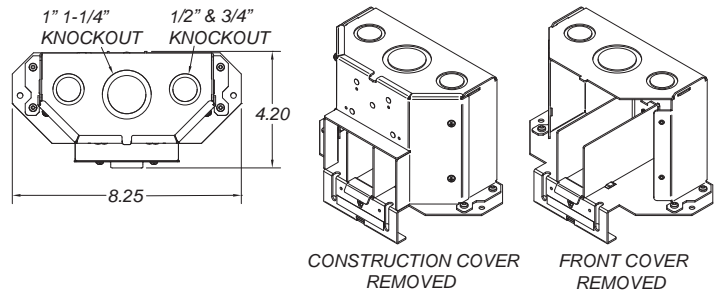

18333 SW-RINLP-ALM

18334 SW-RINLP-SLT

On-wall feed with cover. Use with SW-WF-RIN in-wall rough-in feed to pass wires through and into the raceway.

SW-RINLP

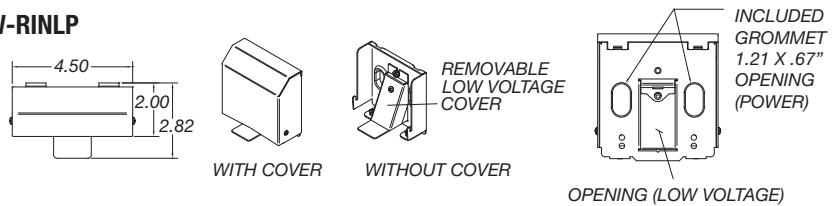

For Surface Mount Applications

18221 SW-WF-RCWY-ALM

18222 SW-WF-RCWY-SLT

Kits contains:

- 1 Smart-Way Wall Feed Box
- 1 Hubbell 1G Low Profile Box (PW1LPB)
- 1 Hubbell 1G Box Cover (KP14)
- 1 Hubbell Flat Elbow (PW1FE)
- 2 Hubbell 30" Wall Track (PW1BC)

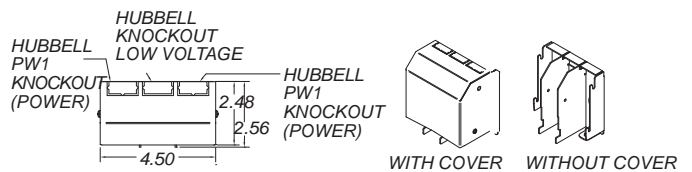

Smart-Way Raceway wall feed kit, closeup.



Smart-Way Raceway with wall feed kit, power and data.

18320 SW-FCT-SLT

Surface mount conduit transition In-Feed with removable dividers. Its small design allows wires and cables transition from conduit to the Smart-Way raceway.

SW-FCT-SLT

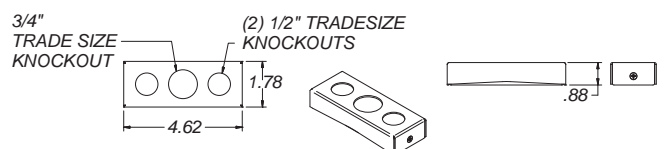

Additional In-Feeds

18326 SW-PKF-SFI

Poke through to Smart-Way In-Feed. Allows power and data to feed the raceway through fire rated concrete floors. To be used with FSR 4" SF-CPT-FF-ALM poke through.

18328 SW-DB-HPP

Power Pole to Smart-Way In-Feed. Feed power and data to the raceway from the ceiling with a power pole. To be used with Hubbell aluminum service pole HBLPP- .

SW-PFK-SFIT4

POKE-THRU SOLD SEPARATELY
FSR POKE-THRU: SF-CPT-FF-ALM
HUBBLE POKE-THRU: S1R4PTFFALU

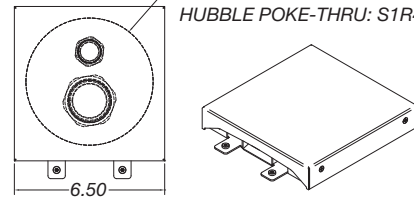

SW-DB-HPP

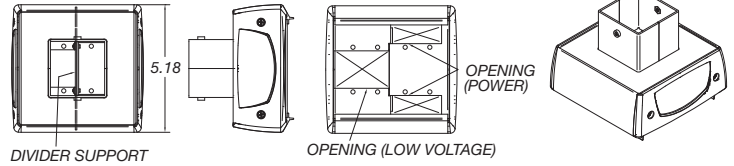

Smart-Way Installation Accessories

18206 SW-END-SLT Raceway End Stop - Slate
*Required at the end of the raceway

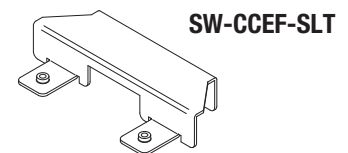
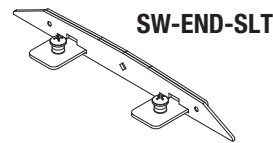

18308 SW-CCEF-SLT Center Channel End Feed
(same as stick end)

18318 SW-DB-2GEXT Device Box
18319 SW-DB-3GEXT Extension (1")
(Device Box Not Included)

SW-DB-2GEXT

SW-DB-3GEXT

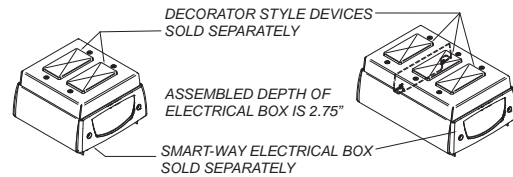

18321 SS-BRSH-BLK Brush Insert for Decora
Opening

18277 SW-CVR-TOOL Smart-Way Cover Removal
Tool

18327 SW-TPE-NO No Transition Flush Plastic
Edging

18307 SW-STRC-6 6 pack of extra couplers

18322 WM-CP-BCKMT Cable Path from Table to
Smart-Way Device Box



Visit www.fsrinc.com for detailed drawings and installation documents.

INSTALLS ON TOP OF OR IN ANY FLOORING



ON-FLOOR
On any Floor Surface
including
Concrete, Wood,
Tile and Laminate



IN-CARPET
In any Carpet
up to .375" thick



IN-LAMINATE
In any Laminate
.21" to .375" thick



IN-WOOD
In Wood .375" to .5"
thick. Over .5" Shim
Raceway Base, Optional
SW-TPE-NO Edging Req.



IN-TILE
In any Tile
between
.21" and .375" thick



IN-TILE
In any Tile .375" to .5"
thick. Over .5" Shim
Raceway Base, Optional
SW-TPE-NO Edging Req.



Specifications are subject to change without notice.

FSR Inc.

244 Bergen Boulevard, Woodland Park, NJ 07424

Phone: 973.785.4347 · Fax: 973.785.4207

Web: www.fsrinc.com · E-mail: sales@fsrinc.com